

temperature

# JOFRA™

### High accuracy

Down to  $\pm 0.04^{\circ}\text{C}$  using the external reference sensor. 4-wire True-Ohm-Measurement technology is used.

### Excellent stability $0.005^{\circ}\text{C}$

### Wide temperature range

RTC-156 from  $-30$  to  $155^{\circ}\text{C}$  ( $-22$  to  $311^{\circ}\text{F}$ )

RTC-157 from  $-45$  to  $155^{\circ}\text{C}$  ( $-49$  to  $311^{\circ}\text{F}$ )

### Improved temperature homogeneity

Unique active dual-zone block ensures good temperature homogeneity in the calibration zone

### DLC Dynamic Load Compensation

Perfect temperature uniformity in the insert, even when calibrating large sensors or many sensors at a time.  
B and C models only

### Display indicator for temperature uniformity

Shows the degree of temperature uniformity in the insert when using the new DLC technology.  
B and C models only

### Intelligent reference sensors

JOFRA reference sensors are supplied with intelligent plugs, holding the calibration data (coefficients) of the reference sensor. This is a truly plug'n'play calibration system

### USB communication

All RTC calibrators communicate via an easy-to-use USB port

### Time-saving

High speed heating and cooling times

### EURAMET

Best performing dry-block with regard to the EURAMET/cg-13/v.01 guideline for testing of dry blocks

ISO 9001 Manufacturer

Specification Sheet, SS-RTC156/157

Best dry-blocks  
on the market!

## Reference Temperature Calibrator Model RTC-156 & RTC-157



AMETEK continues to develop new techniques to improve performance, accuracy, convenience and functionality of the well-known JOFRA calibration products. By doing so, we maintain our position as the leading worldwide manufacturers of temperature dry-block calibrators.

We are proud to introduce our new top model RTC (Reference Temperature Calibrator), which is no exception to the above and even more sophisticated than any existing calibrators.

The RTC offers many new fantastic features, such as:

- Patent pending DLC, Dynamic Load Compensation system, for perfect temperature uniformity in the insert
- Unique intelligent sensors for plug'n'play connection
- USB connector for communication
- Easy-to-read color VGA display with perfect overview of the actual status
- Intuitive, fast and user-friendly navigation
- Lightweight and easy to carry around
- New functional carrying case design
- New multi-hole insert kits covering all the most used sensor sizes
- High profile design and the well-known long lasting JOFRA quality

The new RTC calibrator comes in three different models – A, B, and C.

- RTC-A reference temperature calibrator
- RTC-B reference temperature calibrator with input for reference sensor, DLC sensor and sensors-under-test
- RTC-C reference temperature calibrator with input for reference sensor and DLC sensor

**AMETEK®**  
CALIBRATION INSTRUMENTS

## Unique temperature performance

The RTC series of calibrators provides precision temperature calibration of sensors, whatever the type or format. This is accomplished through an innovative active dual-zone heating technology.

The JOFRA RTC-series features our well-known active dual-zone heating technology. Each heating zone is independently controlled for precision temperature calibration. The homogeneity in the lower part is close to that of a laboratory liquid bath. The lower zone ensures optimum heat dissipation throughout the entire calibration zone. The upper zone compensates for heat loss from the sensor-under-test and from the open top. This design also eliminates the need for extra insulation of sensors-under-test and makes it possible to calibrate liquid-filled and other mechanical sensors.

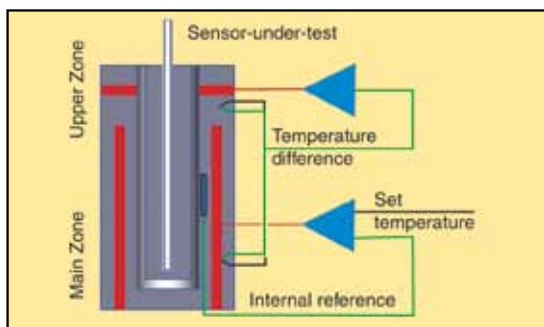

## DLC - Dynamic Load Compensation

**Patent pending!**

To bring our well documented active dual-zone technology to an even higher level, we have developed the patent pending new DLC system.

This newly developed unique feature makes it possible to perform top calibration specifications without being affected by the actual load e.g. many sensors or very big sensors.

A new DLC sensor, Dynamic Load Compensation sensor, has been specially developed for this purpose.

The RTC calibrator features the active dual zone temperature control which improves the homogeneity in the well by adjusting the temperature in the top of the well to the same temperature as in the bottom. The dual zone keeps this difference at a minimum.

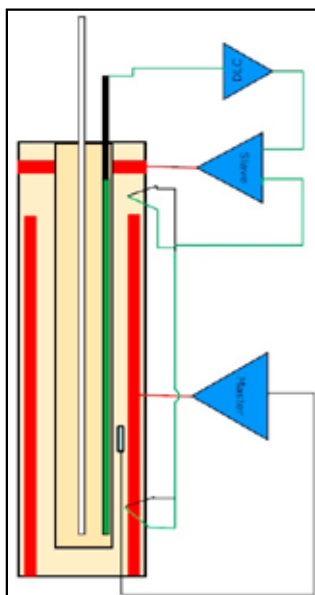

The new DLC sensor improves the homogeneity even more by controlling the homogeneity not only in the well, but also inside the insert, where the sensors-under-test are placed during calibration. The DLC sensor measures the temperature homogeneity in the insert and provides feedback to the active dual-zone system, which now compensates the temperature difference to a minimum inside the insert. In this way, the DLC function makes the homogeneity independent of the different loads of the insert.

Based on the new DLC func-

tionality, the RTC is the best performing dry-block calibrator on the market, when being calibrated and tested according to the globally accepted EURAMET/cg-13/v.01 guideline for calibration and testing of dry-blocks.

The DLC system comprises a special differential temperature sensor designed especially for the RTC. The sensor is placed in the insert and connected to the calibrator. When the DLC function is enabled, the calibrator will automatically equalize the temperature homogeneity inside the insert on top of the normal temperature control and stabilization.

## DLC - User advantages

Calibrating with DLC sensor gives the following advantages:

1. Calibration of several sensors simultaneously
2. Calibration of thick sensors
3. Gives TSL (Thermo Sensitive Length) independency. It is no longer necessary to know the TLS of the sensor
4. Compensates for sensor production tolerances like the PT100 element being mounted in various positions in the sensor
5. Trouble free calibration of sensors with PT100 elements up to 60 mm length
6. The DLC indicator proves that the dual-zone is active and functioning well
7. Proves that the calibrator is working perfect. The DLC value should be very close to 0.00 when the calibrator is loaded with DLC sensor and an external reference sensor
8. Together with the stability indication, the CLD indicates when the calibration values can be read

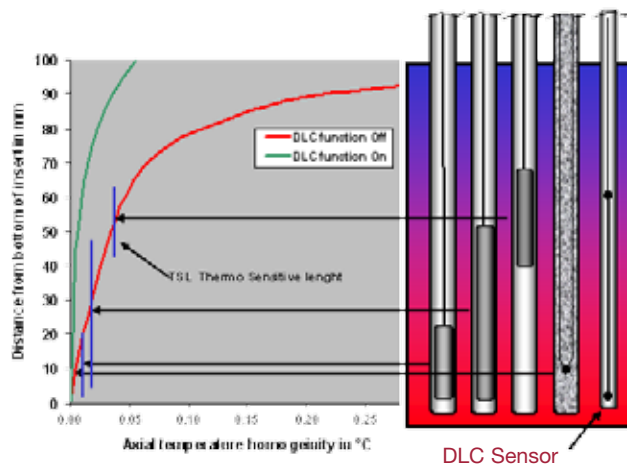

Axial temperature curves for a RTC calibrator with and without the DLC functionality activated

## USB connector for communication

**NEW!**

Another new RTC feature is the USB connection that facilitates easy communication with JOFRACAL. The USB connection also supports easy download of future firmware upgrades.

The new USB connection provides fast and easy access to all laptops without the need of RS-232 to USB converters.

Future-proof through e.g. a flash capability for easy firmware upgrades as well as already integrated LAN communication, SD-card slot and USB host connectors for future use.



## Intelligent reference sensors

The JOFRA STS-200 intelligent reference sensors as well as the new DLC sensor are all containing all individual calibration data regarding the sensor.

Firstly, this means that the time-consuming coefficient downloading sequence with risk of errors is no longer necessary. Secondly, the user can change the reference sensor and be up and running immediately.

With the intelligent sensors, AMETEK has eliminated a source of error and the system is now giving a fail-safe plug'n'play calibration system.



## Unique reference sensors

The new STS-200 reference sensors and the DLC sensors have been specially designed. They are both angled 90° and have been customized to fit the calibrator so they are only slightly higher than the top of the RTC calibrator.

The unique design makes it possible to calibrate threaded sensors and sensors with connection heads without any problems.

## New multi-hole insert kits

Two special multi-hole insert kits have been developed to comply with calibration of almost any sensor diameter without having to buy numerous inserts.

The first kit is a metric insert kit consisting of only four inserts covering all diameters from 3 to 13mm. The other is an imperial insert kit consisting of only three inserts covering six different sizes from 1/8" to 1/2".

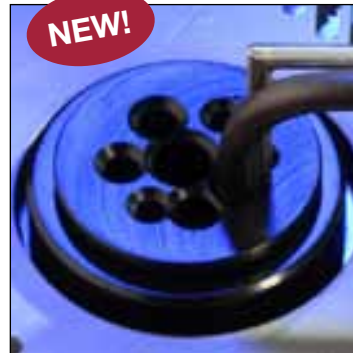

All inserts have holes for both STS reference sensors and DLC sensors.

With this new insert kit in the carrying case, the user is now able to calibrate all commonly known sensor sizes.

These new insert kits are part of the JOFRA light-weight strategy.

## Wide temperature range

The RTC-series can perform calibration over a very wide temperature range starting from -45°C and up to 155°C (-49 to 311°F). This makes it possible to perform calibration jobs over a range of 200°C (360°F) with only one calibrator.

-45°C

## Easy-to-read

### color display and user-friendly navigation

The new 5.7" full color VGA display is very easy to read. The main temperatures, like SET, READ, TRUE and SUT (Sensor under test), are always displayed at all stages of the programming or calibration procedure.

Only 10.5 kg

## Easy to carry

A calibrator is carried from one job to another. Therefore, it is essential that the weight of the calibrator is as low as possible.

We have thoroughly included the weight issue in our design and have developed new design techniques that have made the RTC calibrator lightweight and easy to carry around without compromising its quality, durability and functionality.

The purpose of minimizing the weight of the RTC calibrator is to protect, especially frequent users from overload.

## Same size of inserts

The new cooling calibrator RTC-156/157 are using the same insert dimensions (30x150mm) as some of our existing calibrators. This makes it possible to reuse inserts from other calibrators.

## Fast temperature calibration

Time is money! This is why all the new RTC calibrators have an increased heating and cooling speed compared to all other calibrators. Heating and cooling speed has been increased by up to 20%. The implication is savings in both production downtime and general calibration costs.

-24°C @15 min.

NEW!



The navigation is menu-driven and very logical to use and the display shows any important information needed for the current function in use. The communication windows pop up and are followed by discrete sound messages. The display is very bright and the main information can easily be read from a distance.

The large display contains more detailed information at a glance, such as:

- Stability status
- Load compensation status
- Real time clock
- Serial number of reference sensor
- Sensor-under-test status

**NEW!**

## Special designed carrying case

AMETEK has designed an all-in-one-handle carrying case.

We have now made it possible to store both the STS reference sensors and DLC sensors in the carrying case with an optimum physical protection. There is room for inserts and insulation plugs to cover all dimensions and compartments for the new integrated support rod set, wires, manuals, certificates, plugs, insert tools etc.

All rooms are specially designed to hold one of the above mentioned items. This makes it very easy to keep track of any accessories.

For optimum protection of the calibrator and the accessories, the compartments are designed to hold the accessories fixed during transportation.

## Integrated support rod

The new integrated support rod is part of the reduced weight philosophy. It is lightweight and very easy to mount on the RTC. Two fixing holes are integrated in the calibrator where the support rods can be mounted.



## MVI - Secure temperature stability

MVI stands for "Mains power Variance Immunity". Unstable mains power is a major contributor to on-site calibration inaccuracies. Traditional temperature calibrators often become unstable in production environments where large electrical motors, heating elements, and other devices are periodically cycled on or off. The cycling of supply power can cause the temperature regulator to perform inconsistently, leading to both inaccurate readings and unstable temperatures.

The JOFRA RTC calibrators all employ the MVI functionality, thus avoiding such stability problems. The MVI functionality is obtained by running the calibrator on stabilized DC voltage.

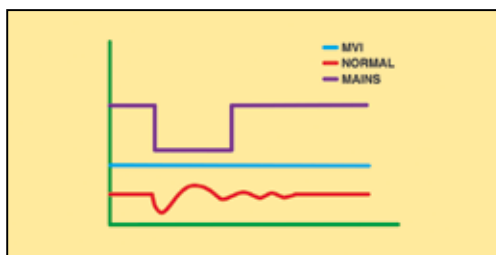

## Highest accuracy (model B & C only)

The RTC series calibrators may be supplied with a built-in reference thermometer to be used with an external reference sensor. This feature allows the instrument to perform calibrations on-site, while maintaining a high accuracy.

A special 90° angled external reference sensor has been designed to accommodate calibration of sensors with a transmitter head, top connector or similar arrangement. The user can decide whether to read the built-in reference sensor or the more accurate angled reference sensor from the large, easy-to-read LCD display of the calibrator. The external sensor and the internal sensor readings are independent of one another.

## SET-Follows-TRUE (model B & C only)

Available on B and C models only, the "SET-Follows-TRUE" makes the instrument tune in until the temperature reading of the external reference "TRUE" meets the desired "SET" temperature. This feature is important when it is critical that the temperature of the calibration zone matches the desired temperature when measured with accurate external reference sensors.

## Reading of sensor-under-test (model B only)

Model B of the RTC is equipped with a built-in accurate measuring circuit for sensor-under-test (input), which enables measurement of virtually any type of temperature sensors including: Resistance thermometers (RTD), thermocouples (TC), transmitters, milliamps (mA), voltage (V) and thermostats

The RTC calibrators can be user-programmed from the keyboard for fully automatic sensor calibrations. Once the unit is programmed, the instrument is self-operating and performs the configured calibration routine. All calibration data are stored and can be read in the display.



## Switch test (model B only)

Users may perform a thermostatic test and find "Open", "Closed" and the hysteresis (deadband) automatically. The instrument retains the last twenty test results.

## Auto-stepping

Up to 20 different temperature steps may be programmed including the hold time for each step. Upon completion of an auto step routine, the user can easily read the results for the sensor-under-test on the RTC display. Results from twenty auto-step calibrations are stored.

The "Set temperature" feature allows the user to set the exact desired temperature with a resolution of 0.001°.



## Enhanced stability

A stability indicator shows when the RTC calibrator has reached the desired temperature and is stable. The user may change the stability criteria for the external reference and the sensor-under-test quickly and simply. The stability criterion is the user's security of a correct calibration. A count-down timer is displayed next to the temperature read-out.

## Instrument setups

The RTC series allows the user to store up to ten (10) complete instrument setups. You may store all sorts of information including temperature units, stability criteria, use of external reference sensors, resolutions, sensors-under-test (SUT), conversions to temperature, display contrasts, etc. The setup may be recalled at any time.

## Maximum and minimum temperature

From the setup menu, the user can select the maximum and minimum temperature limit for the calibrator. This function prevents damage to the sensor-under-test caused by excessive temperatures and it helps reducing sensor drift from exposures of too high temperatures. This feature can be locked with an access code.

## Silent Operation

The RTC calibrator can be programmed to run in silent operation. This function is an advantage if calibrating in a laboratory or in an office. If used in silent operation the calibrator is not using its full speed potential.

## As found/As left (model B only)

When running a calibration initiated from a work order, the user can select the calibration as an As Found or an As Left calibration.

## SYNC output

A synchronization output signals when the instrument is stable and may be used with ancillary devices such as video recorders, digital cameras or as an input to a data logging device. The SYNC output may be useful for automating and documenting your calibrations when calibrating external reading devices.

## Calibration of indication devices

When calibrating an indicating device in the work order mode, users may key in the results during or after the test. Using the "Calibration info" function, the user may view the complete calibration task, including the "Scenario" before the calibration takes place.

## Hardware requirements

- INTEL™ 486 processor
- (PENTIUM™ 800 MHz recommended)
- 32 MB RAM (64 MB recommended)
- 80 MB free disk space on hard disk prior to installation
- Standard VGA (800 x 600, 16 colors) compatible screen
- (1024 x 786, 256 colors recommended)

## JOFRACAL calibration software

JOFRACAL is a highly versatile calibration software that is supplied together with the RTC calibrators. The software ensures easy calibration of all kind of temperature sensors, such as RTD's, thermocouples, transmitters and thermoswitches. Furthermore, it can be used for pressure calibration i.e. pressure gauges and pressure switches. JOFRACAL integrates with JOFRA calibration instruments. As for temperature calibrators, it is the whole range of temperature calibrators. Regarding pressure calibrators, it integrates with DPC-500, HPC and IPI pressure calibrators. JOFRACAL also has full integration with the series of signal calibrators.

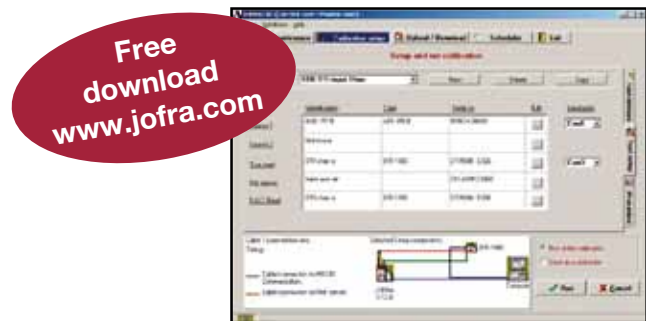

JOFRACAL may also be used for manual calibrations, as it can be set up to accept manual entry of calibration data together with other liquid baths, ice points or dry-block heat sources.

The calibration data collected can be stored on a PC for later recall or analysis. The RTC calibrator stores the calibration procedure and may be taken out to the process site without bringing a personal computer.

This allows the RTC calibrator to:

- Operate as a stand-alone instrument, using advanced calibration routines without the assistance of a personal computer on site. The work order functionality
- Prevent unauthorized changes to a calibration routine. Personnel who are not authorized to alter a calibration routine cannot do so

Once all calibrations are completed, the data may be uploaded to the JOFRACAL for printing of certificates. The data collected may be stored on the personal computer for later recall or analysis.

JOFRACAL offers extended output formats of the captured calibration data such as PDF file format and ASCII/semicolon separated text format for further processing and calculation of data in spreadsheets and word processors.

## Calibration of up to 24 sensors with JOFRA ASM

Using the JOFRA RTC series together with the ASM, Advanced Signal Multi-scanner, offers a great time-saving automatic solution to calibrate multiple temperature sensors at the same time. The ASM series is an eight channel scanner controlled by the JOFRACAL software on a PC. Up to 3 ASM units can be stacked to calibrate up to 24 sensors at a time. It can handle signals from 2-, 3- and 4 wire RTD's, thermocouples, transmitters, temperature switches and voltage.

## FUNCTIONAL SPECIFICATIONS

### Temperature range

RTC-156  
 @ ambient temp. 0°C/32°F ..... -46 to 155°C/-51 to 311°F  
 @ ambient temp. 23°C/73°F ..... -30 to 155°C/-22 to 311°F  
 @ ambient temp. 40°C/104°F .... -15 to 155°C/ 5 to 311°F  
 RTC-157  
 @ ambient temp. 0°C/32°F ..... -57 to 155°C/-71 to 311°F  
 @ ambient temp. 23°C/73°F ..... -45 to 155°C/-49 to 311°F  
 @ ambient temp. 40°C/104°F .... -31 to 155°C/-24 to 311°F

### Accuracy (model B & C) with external STS ref. sensor

RTC-156 B & C ..... ±0.04°C/±0.07°F  
 RTC-157 B & C ..... ±0.04°C/±0.07°F  
 12-month period. Relative to reference standard. Specifications by use of the external JOFRA STS-200 reference sensor

### Accuracy with internal reference sensor

RTC-156 A, B & C ..... ±0.10°C/±0.18°F  
 RTC-157 A, B & C ..... ±0.10°C/±0.18°F

### Stability

RTC-156 ..... ±0.005°C/±0.009°F<sup>1)</sup>  
 RTC-157 ..... ±0.005°C/±0.009°F<sup>1)</sup>  
 Measured after the stability indicator has been on for 15 minutes. Measuring time is 30 minutes.

### Radial homogeneity (difference between holes)

RTC-156 ..... 0.01°C/0.02°F  
 RTC-157 ..... 0.01°C/0.02°F

### Resolution (user-selectable)

All temperatures ..... 1° or 0.1° or 0.01° or 0.001°

### Heating time

RTC-156 -30 to 23°C/-22 to 73°F ..... 4 minutes  
 23 to 155°C/73 to 311°F ..... 15 minutes  
 RTC-157 -45 to 23°C/-49 to 73°F ..... 7 minutes  
 23 to 155°C/73 to 311°F ..... 8 minutes

### Cooling time

RTC-156 155 to 100°C/311 to 212°F ..... 4 minutes  
 100 to 23°C/212 to 73°F ..... 8 minutes  
 23 to -24°C/73 to -11°F ..... 15 minutes  
 -24 to -30°C/-11 to -22°F ..... 10 minutes  
 RTC-157 155 to 100°C/311 to 212°F ..... 5 minutes  
 100 to 23°C/212 to 73°F ..... 10 minutes  
 23 to -30°C/73 to -22°F ..... 17 minutes  
 -30 to -45°C/-22 to -49°F ..... 25 minutes

### Time to stability (approx.)

RTC-156 ..... 10 minutes  
 RTC-157 ..... 10 minutes

### Immersion depth

RTC-156 ..... 160 mm/6.3 in  
 RTC-157 ..... 160 mm/6.3 in

## INPUT SPECIFICATIONS

All input specifications apply to the dry-block of the calibrator running at the respective temperature (stable plus an additional 20 minute period).

All input specifications are valid for RTC-156 and RTC-157.

### RTD reference input (B & C models only)

Type ..... 4-wire RTD with true ohm measurements<sup>1)</sup>  
 F.S. (Full Scale) ..... 400 ohm  
 Accuracy (12 months) ..... ±(0.0012% rdg. + 0.0005% F.S.)

RTD Type	Temperature		12 months	
	°C	°F	°C	°F
Pt100 reference	-50	-58	±0.008	±0.015
	0	32	±0.008	±0.015
	155	311	±0.011	±0.019

Note 1: True ohm measurement is an effective method to eliminate errors from induced thermoelectrical voltage

### DLC sensor input (B & C models only)

Type	Temperature		12 months	
	°C	°F	°C	°F
DLC 155	-50	-58	±0.014	±0.025
	0	32	±0.010	±0.018
	155	311	±0.010	±0.018

### RTD sensor under test input (B model only)

F.S. (range) ..... 400 ohm  
 Accuracy (12 months) ..... ±(0.002% Rdg.+0.002% F.S.)  
 F.S. (range) ..... 4000 ohm  
 Accuracy (12 months) ..... ±(0.005% Rdg. + 0.005% F.S.)  
 2-wire ..... add 50 mOhm

RTD Type	Temperature		12 months	
	°C	°F	°C	°F
Pt1000	-50	-58	±0.064	±0.115
	0	32	±0.073	±0.131
	155	311	±0.076	±0.136
Pt500	-50	-58	±0.115	±0.191
	0	32	±0.127	±0.228
	155	311	±0.142	±0.255
Pt100	-50	-58	±0.026	±0.046
	0	32	±0.026	±0.046
	155	311	±0.030	±0.054

## Thermocouple input

Range ..... ±78 mV  
 F.S. (Full Scale) ..... 78 mV  
 Accuracy (12 months) ..... ±(0.005% Rdg. + 0.005% F.S.)

TC Type	Temperature		12 months*	
	°C	°F	°C	°F
E	-50	-58	±0.09	±0.17
	0	32	±0.06	±0.11
	155	311	±0.06	±0.11
J	-50	-58	±0.10	±0.18
	0	32	±0.08	±0.14
	155	311	±0.09	±0.16
K	-50	-58	±0.14	±0.24
	0	32	±0.10	±0.19
	155	311	±0.11	±0.20
T	-50	-58	±0.15	±0.26
	0	32	±0.10	±0.18
	155	311	±0.08	±0.15
R	-50	-58	±1.30	±2.35
	0	32	±0.78	±1.40
	155	311	±0.47	±0.84
S	-50	-58	±0.98	±1.76
	0	32	±0.78	±1.40
	155	311	±0.49	±0.89
N	-50	-58	±0.20	±0.35
	0	32	±0.15	±0.27
	155	311	±0.13	±0.23
XK (only in Russian versions)	-50	-58	±0.09	±0.15
	0	32	±0.06	±0.11
	155	311	±0.06	±0.11
U	-50	-58	±0.13	±0.24
	0	32	±0.10	±0.18
	155	311	±0.08	±0.14

\* Excl. CJC accuracy ±0.3°C / ±0.54°F

## Transmitter supply

Output voltage..... 24VDC ±10%  
 Output current..... Maximum 28 mA

## Transmitter input mA (B model only)

Range ..... 0 to 24 mA  
 Accuracy (12 months) ..... ±(0.005% Rdg. + 0.010% F.S.)

## Voltage input VDC (B model only)

Range: ..... 0 to 12 VDC  
 Accuracy (12 months) ..... ±(0.005% Rdg. + 0.010% F.S.)

## Switch input (B model only)

Switch dry contacts  
 Test voltage..... Maximum 5 VDC  
 Test current..... Maximum 2.5 mA

## Mains specifications

Voltage ..... 115V (90-127) / 230V (180-254)  
 Frequency, non US deliveries ..... 50 Hz ±5, 60 Hz ±5  
 Frequency, US deliveries ..... 60 Hz ±5  
 Power consumption (max.) ..... 400 W

## Communication interface

Serial data interface ..... USB 2.0 device port  
 Serial data interface ..... USB 2.0 host double port\*  
 LAN..... Ethernet MAC 10/100 Base-T\*  
 SD..... SD slot\*  
 \* for future expansion

## Miscellaneous

Operating temperature ..... 0 to 40°C/32 to 104°F  
 Storage temperature ..... -20 to 50°C/-4 to 122°F  
 Humidity ..... 0 to 90% RH  
 Protection class ..... IP-10

## PHYSICAL SPECIFICATIONS

### Weight and instrument size (L x W x H)

RTC-156/157 ..... 10.5 kg/23.2 lb  
 RTC-156/157 ..... 362 x 171 x 363 mm/14.3 x 6.7 x 14.3 in

### Shipping (without carrying case)

RTC-156/157 ..... 14.8 kg/32.6 lb  
 Size..... 570 x 235 x 440 mm/22.4 x 9.3 x 17.3 in

### Shipping (including optional carrying case)

RTC-156/157 ..... 20.5 kg/45.1 lb  
 Size..... 650 x 380 x 500 mm/25.5 x 14.9 x 19.7 in

### Shipping (carrying case only)

Weight ..... 8.0 kg/13.2 lb  
 Size..... 650 x 380 x 500 mm/25.5 x 14.9 x 19.7 in

## INSERTS

### Insert dimensions

RTC-156/157 outer diameter ..... 29.7 mm/1.17 in  
 RTC-156/157 inner diameter (multi hole)..... 25.6 mm/1.01 in  
 RTC-156/157 inner diameter (single hole) .22.0 mm/0.87 in  
 RTC-156/157 length..... 150 mm/5.91 in

### Weight of non-drilled insert (approx.)

RTC-156/157 ..... 290 g/10.2 oz

## PREDRILLED INSERTS FOR RTC-156/157

All predrilled inserts have holes for:  
 4 mm reference sensor • ¼" reference sensor • 3 mm hole for DLC sensor  
 All inserts are supplied with an insulation plug drilled with the necessary holes

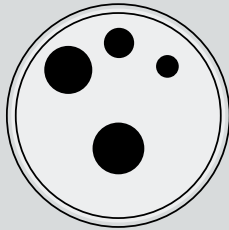

Spare part no. for predrilled inserts with reference holes		
Sensor diameter	Instrument	
	Insert code <sup>1</sup>	RTC-156/157 A/B/C
3 mm	003	127312
4 mm	004	127313
5 mm	005	127314
6 mm	006	127315
7 mm	007	127316
8 mm	008	127317
9 mm	009	127318
10 mm	010	127319
11 mm	011	127320
12 mm	012	127321
13 mm	013	127322
14 mm	014	127323
15 mm	015	127324
16 mm	016	127325
Package of the above inserts	SMM	127336

Spare part no. for predrilled inserts with reference holes		
Sensor diameter	Instrument	
	Insert code <sup>1</sup>	RTC-156/157 A/B/C
1/8 in	125	127302
3/16 in	187	127303
1/4 in	250	127304
5/16 in	312	127305
3/8 in	375	127306
7/16 in	437	127307
1/2 in	500	127308
9/16 in	562	127309
5/8 in	625	127310
Package of the above inserts	SIM	127335

Note 1: Use the insert code, when ordering a JOFRA standard insert together with the RTC calibrator

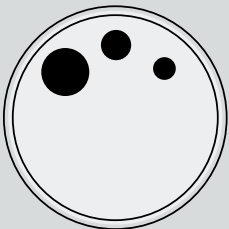
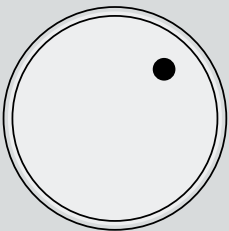

## UNDRILLED INSERTS FOR RTC SERIES

Inserts, undrilled incl. insulation plugs		
Inserts	Instrument	
	Insert code <sup>1</sup>	RTC-156 A/B/C
5-pack, undrilled inserts with no holes	UN1	127299
5-pack, undrilled inserts with hole for DLC sensor	UN2	127300
5-pack, undrilled inserts with 2 holes for STS reference sensors (4mm & ¼") and 1 hole for DLC sensor	UN3	127301
Undrilled insulation plug		122781

Note 1: Use the insert code, when ordering a JOFRA standard undrilled insert together with the RTC calibrator



Picture 1



Picture 2

## APPLICATION KIT FOR CALIBRATION OF SANITARY SENSORS

Picture 1 shows a custom-made insert and our STS-102 A cable reference sensor placed in a RTC-156 calibrator. Picture 2 shows the sanitary sensor when fitted into the insert, ready for calibration. Note that the design makes room for the reference sensor cable. Complete STS102 application kit for RTC-156 model B and C including STS102A030EH, recalibration tube, 5-Pack undrilled flange insertion tubes with cable groove, and carrying case. Order No. 127279



**MULTI-HOLE INSERTS FOR RTC-156/157 - METRIC (MM)**

All inserts are supplied with an insulation plug drilled with the necessary holes

Spare part no. for multi-hole inserts - metric (mm)		
Insert type	Instrument	
	Insert code <sup>1</sup>	RTC-156/157 A/B/C
Multi-hole type 1	M01	127329
Multi-hole type 2	M02	127330
Multi-hole type 3	M03	127331
Multi-hole type 4	M04	127332
Multi-hole type 7	M07	127241
Multi-hole type 8	M08	127242
Multi-hole type 9	M09	127243
Set of 4 Metric Multi Inserts, 3mm to 16mm (Incl. 127332, 127241, 127242 and 127243)	SM	127326

Note 1: Use the insert code, when ordering a JOFRA standard multi-hole insert together with the RTC calibrator

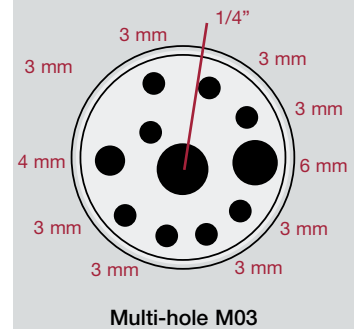
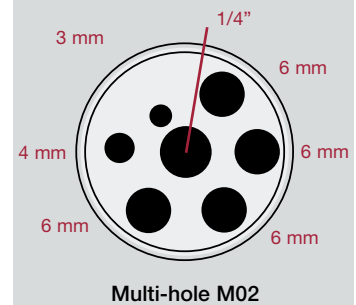
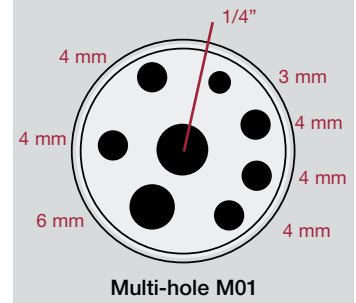
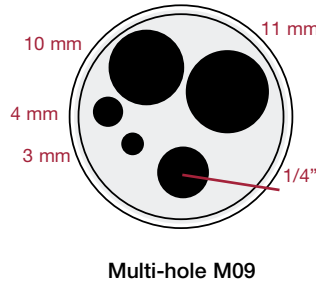
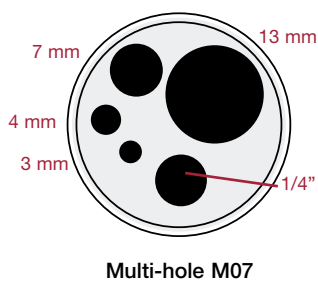
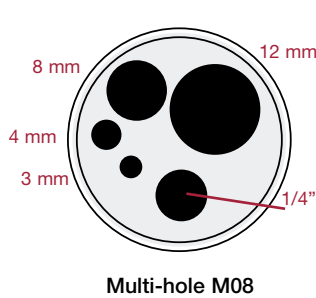
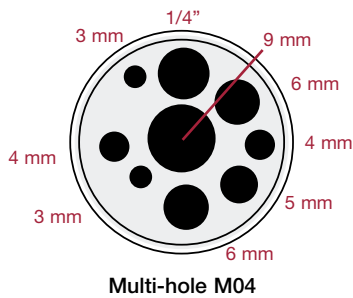

**MULTI-HOLE INSERTS FOR RTC-156/157 - IMPERIAL (INCH)**

All inserts are supplied with an insulation plug drilled with the necessary holes

Spare part no. for multi-hole inserts - imperial (inch)		
Insert code	Instrument	
	Insert code <sup>1</sup>	RTC-156/157 A/B/C
Multi-hole type 5	M05	127327
Multi-hole type 6	M06	127328
Multi-hole type 10	M10	127247
Set of 3 Imperial Multi Inserts, 1/8 to 1/2 inch (Incl. 127308, 127328 and 127247)	SI	127311

Note 1: Use the insert code, when ordering a JOFRA standard multi-hole insert together with the RTC calibrator

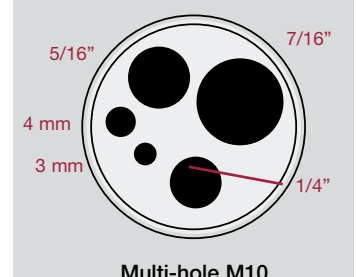
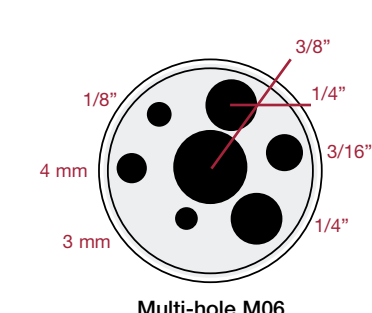
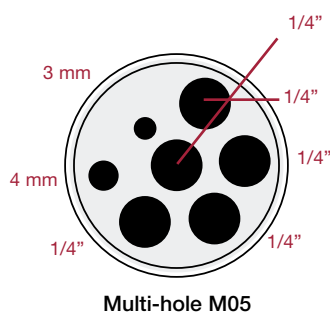

## STANDARD DELIVERY

Model A, B and C:

- RTC dry-block calibrator (user specified)
- Mains power cable (user specified)
- Traceable certificate - temperature performance
- Tool for insertion tubes
- JOFRACAL
- USB cable
- Set of rubber cones for insulation plugs
- Manual

Model B instruments contain the following extra items:

- Test cables (2 x red, 2 x black)
- Traceable certificate - input performance for reference sensor and DLC sensor
- Traceable certificate - input performance for sensor-under-test inputs

Model C instruments contain the following extra items:

- Traceable certificate - input performance for reference sensor and DLC sensor

## ACCESSORIES

- 125066 Extra fixture for sensor grib
- 125067 Extra sensor grib
- 122771 Mini-Jack connector for stable relay output
- 120516 Thermocouple Male Plug - Type J - Black
- 120517 Thermocouple Male Plug - Type K - Yellow
- 120514 Thermocouple Male Plug - Type N - Orange
- 120515 Thermocouple Male Plug - Type T - Blue
- 120518 Thermocouple Male Plug - Type R / S - Green
- 120519 Thermocouple Male Plug - Type Cu-Cu - White

## OPTIONS

**NEW!**

### Carrying Case - Option CT

With our new special designed carrying case it is now possible to store all your sensors in the case with an optimum physical protection. With improved integrated trolley system for easy and safe transportation.



### Support rod set - Option SR



Support rod for sensors to be mounted on all JOFRA RTC dry-block calibrators. Holds the sensor under test in its position, while calibrating. Includes 2 sensor grips and 2 fixtures for sensor grips.



## FUNCTIONAL COMPARISON

	Model A	Model B	Model C
Dual-zone heating/cooling block	•	•	•
MVI - Mains Variance Immunity (or similar)	•	•	•
Stability indicator	•	•	•
Automatic step function	•	•	•
USB communication	•	•	•
Display resolution 0.001°	•	•	•
Programmable max. temperature	•	•	•
SYNC output (for external recording device)	•	•	•
Calibration of short sensors in special insert		•	•
External precision reference sensor input		•	•
External precision DLC reference sensor input		•	•
"SET" follows "TRUE"		•	•
Load compensation functionality		•	•
Input for RTD, TC, V, mA		•	
4-20 mA transmitter input incl. 24 VDC supply		•	
All inputs scalable to temperature		•	
Automatic switch test (open, close and hysteresis)		•	
Download of calibration work orders from PC		•	
Upload of calibration results (as found & as left)		•	

**ORDERING INFORMATION**

Order number								Description						
RTC156								<b>Base model number</b>						
RTC157								RTC-156 Series, -30°C to 155°C (-22°F to 311°F)						
								RTC-157 series, -45°C to 155°C (-49°F to 311°F)						
								<b>Model version</b>						
	A							Basic model, without input						
	B							Full model, incl. DLC sensor input, Reference sensor input, Sensor-under-test input						
	C							Middle model, incl. DLC sensor input, Reference sensor input,						
		<b>Power supply (US deliveries 60 Hz only)</b>												
		115						115VAC						
		230						230VAC						
			<b>Mains power cable</b>											
			A					European, 230V						
			B					USA/Canada, 115V						
			C					UK, 240V						
			D					South Africa, 220V						
			E					Italy, 220V						
			F					Australia, 240V						
			G					Denmark, 230V						
			H					Switzerland, 220V						
			I					Israel, 230V						
				<b>Insert type and size</b>										
				NON				No insert selected (standard)						
				UNX				1 x Undrilled Insert (Please see Insert selection for code)						
				XXX				1 x Single hole insert (Please see Insert selection for code)						
				MXX				1 x Multi hole insert (Please see Insert selection for code)						
				SIX				Set of 3 Imperial multi hole inserts. Covering holes from 1/8" to 1/2"						
				SMX				Set of 4 Metric multi hole inserts. Covering holes from 3mm to 13mm						
				SIM				Set of 9 Imperial inserts. Covering holes from 1/8" to 5/8"						
				SMM				Set of 14 Metric inserts. Covering holes from 3mm to 16mm						
					<b>Dynamic Load Compensation (B &amp; C models only, optional)</b>									
					DLC			DLC sensor						
						<b>STS Reference sensor (B &amp; C models only, optional)</b>								
						R1			STS-102 Ref. sensor. Dia. 4mm. Length 30mm (STS102A030EH)					
						R2			STS-200 Ref. sensor. Dia. 4mm. Length 161mm (STS200A915EH)					
						R3			STS-200 Ref. sensor. Dia. 1/4". Length 161mm (STS200B915EH)					
							<b>Calibration Certificate</b>							
						F			Traceable Callibration Certificate. (standard)					
						H			Accredited Calibration Certificate					
						EA			Full EURAMET Calibration Certificate					
						FS			Traceable System Calibration Certificate (B & C model only)					
						HS			Accredited System Calibration Certificate (B & C model only)					
						EAS			Full EURAMET System Calibration Certificate (B & C model only)					
						EASD			Full EURAMET System Calibration Certificate with DLC (B & C model only)					
							<b>Accessories</b>							
							CT			Solid Protective Carrying case with trolley				
							SR			Support rod set				
							TR			Solid Protective Carrying case with trolley & Support rod set				
								<b>Sample order number</b>						
RTC156	B	230	A	SM	DLC	R2	EA	CT	JOFRA RTC-156 B with 230VAC, EU power cord, set of metric inserts, DLC, STS-200 ref. sensor, full EA temp. calibration certificate, and carrying case with trolley.					



#### **AMETEK Calibration Instruments**

is one of the world's leading manufacturers and developers of calibration instruments for temperature, pressure and process signals as well as for temperature sensors both from a commercial and a technological point of view.

#### **JOFRA Temperature Instruments**

Portable precision thermometers. Dry-block and liquid bath calibrators: 5 series, with more than 25 models and temperature ranges from -90° to 1205°C / -130° to 2200°F. All featuring speed, portability, accuracy and advanced documenting functions with JOFRACAL calibration software.

#### **JOFRA Pressure Instruments**

Convenient electronic systems ranging from -25 mbar to 1000 bar (0.4 to 15,000 psi) - multiple choices of pressure ranges, pumps and accuracies, fully temperature-compensated for problem-free and accurate field use.

#### **JOFRA Signal Instruments**

Process signal measurement and simulation for easy control loop calibration and measurement tasks - from handheld field instruments to laboratory reference level bench top instruments.

#### **JOFRA / JF Marine Instruments**

A complete range of calibration equipment for temperature, pressure and signal, approved for marine use.

#### **FP Temperature Sensors**

A complete range of temperature sensors for industrial and marine use.

#### **M&G Pressure Testers**

Pneumatic floating-ball or hydraulic piston dead weight testers with accuracies to 0.015% of reading.

#### **M&G Pumps**

Pressure generators from small pneumatic "bicycle" style pumps to hydraulic pumps generating up to 1,000 bar (15,000 psi).

*...because calibration is  
a matter of confidence*

**AMETEK**<sup>®</sup>  
CALIBRATION INSTRUMENTS

**AMETEK Denmark A/S**  
Gydevang 32-34 | 3450 Allerød | Denmark  
T: +45 4816 8000 | [ametek@ametek.dk](mailto:ametek@ametek.dk)

*Sales & Service:*  
Europe, Asia, Africa, Middle East and South America

Information in this document is subject to change without notice. ©2009, by AMETEK, Inc., [www.ametek.com](http://www.ametek.com). All rights reserved.

#### **AMETEK Mansfield & Green (North America)**

T: +1 800 527 9999 | [cal.info@ametek.com](mailto:cal.info@ametek.com)

#### **AMETEK Singapore Pte. Ltd. (Singapore)**

T: +65 6 484 2388 | [aspl@ametek.com.sg](mailto:aspl@ametek.com.sg)

#### **AMETEK Inc. Beijing Rep. Office (China)**

T: +86 10 8526 2111 | [jofra@ametek.com.cn](mailto:jofra@ametek.com.cn)

#### **AMETEK GmbH (Germany)**

T: +49 2159 9136 510 | [info.mct-de@ametek.de](mailto:info.mct-de@ametek.de)

#### **AMETEK Calibration Instruments (UK)**

T: +44 (0) 1243 833 302 | [jofra@ametek.co.uk](mailto:jofra@ametek.co.uk)

**[www.jofra.com](http://www.jofra.com)**